

3 603 C44 301
 Issue } 11-09-14
 Stand }

Fig./Abb. 1

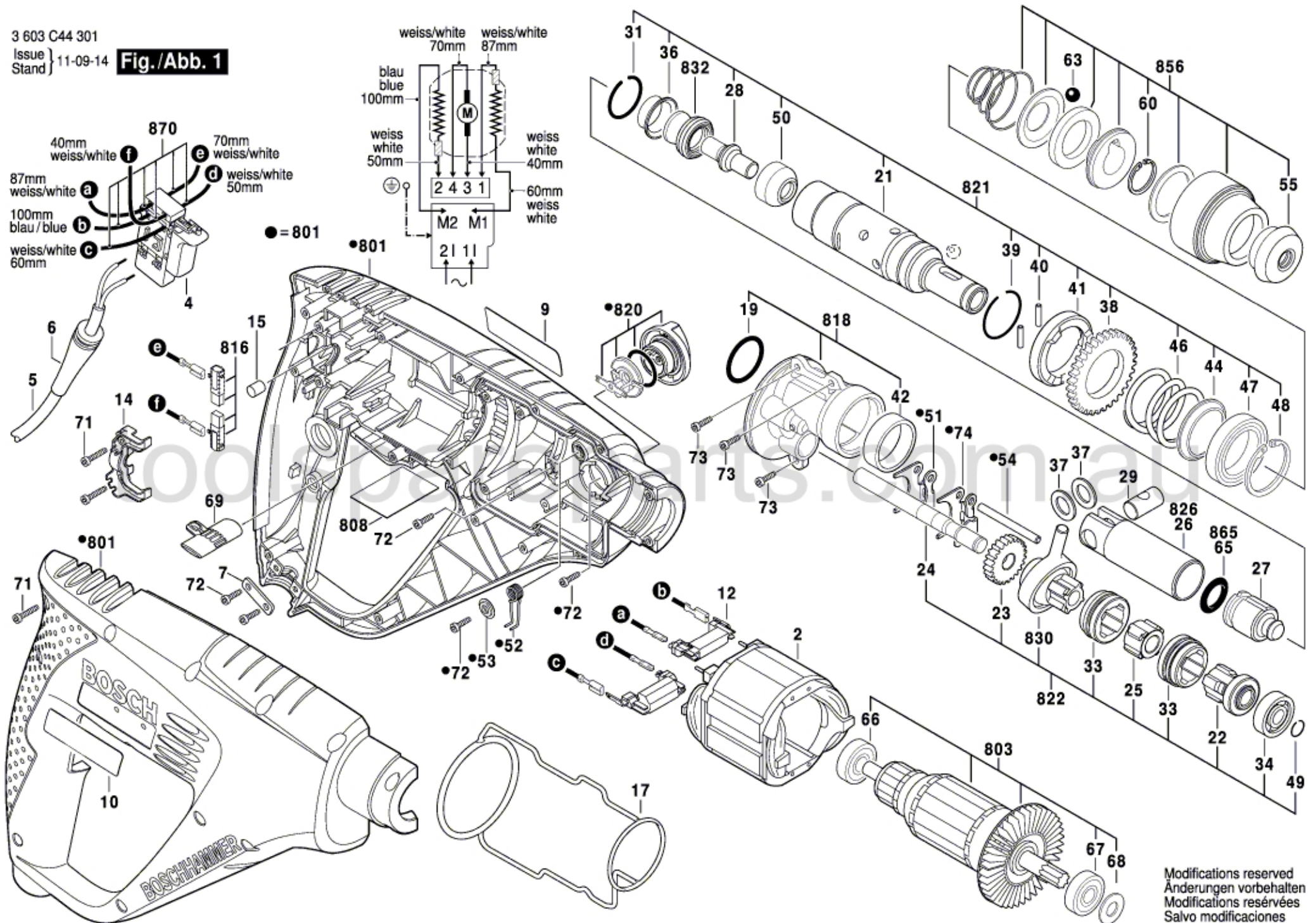

Modifications reserved
 Änderungen vorbehalten
 Modifications réservées
 Salvo modificaciones